



## FEATURES

- High linearity
- Bandwidth 10 GHz, 20 GHz, 40 GHz
- High stability
- Low insertion loss
- Operation in C and L bands

## APPLICATIONS

- RoF
- Antenna remoting
- Microwave and Radar links
- Space and defence systems

## OPTIONS

- 1300 nm, 1000 nm, 800 nm versions
- Hermetic sealing
- Space qualified

## RELATED EQUIPMENTS

- DR-AN RF amplifiers
- MBC ditherless Bias Controllers
- Turn-key ModBox systems

The MXAN-LN series are high bandwidth intensity modulators specially designed for the transmission of analog signals over optical fibers.

The MXAN-LN's performance parameters meet the requirement of the most demanding analog transmission links for military and civil applications: the x-cut design offers an unmatched stability, the low insertion loss optimizes links gain and the high linearity preserves the signal quality. They are specially suitable for microwave links and remoted antennas.

## MXAN-LN-10 Performance Highlights

Parameter	Min	Typ	Max	Unit
Operating wavelength	1530	-	1625	nm
Insertion loss	-	3.5	-	dB
Insertion loss (with low IL option)	-	2.7	3	dB
Electro-optical bandwidth	10	12	-	GHz
$V_{\pi}$ RF @ 50 kHz	-	5.5	-	V

Specifications given at 25 °C, 50  $\Omega$ , 1550 nm

## MXAN-LN-20 Performance Highlights

Parameter	Min	Typ	Max	Unit
Operating wavelength	1530	-	1625	nm
Insertion loss	-	3.5	-	dB
Electro-optical bandwidth	20	25	-	GHz
$V_{\pi}$ RF @ 50 kHz	-	5	-	V
2 <sup>nd</sup> harmonic suppression ratio	-	60	-	dB

Specifications given at 25 °C, 50  $\Omega$ , 1550 nm

## MXAN-LN-40 Performance Highlights

Parameter	Min	Typ	Max	Unit
Operating wavelength	1530	-	1625	nm
Insertion loss	-	3.5	-	dB
Electro-optical bandwidth	28	30	-	GHz
$V_{\pi}$ RF @ 50 kHz	-	5	-	V
2 <sup>nd</sup> harmonic suppression ratio	-	60	-	dB

Specifications given at 25 °C, 50  $\Omega$ , 1550 nm

## MXAN-LN-10

### 10 GHz Analog Intensity Modulator

#### Electrical Characteristics

Parameter	Symbol	Condition	Min	Typ	Max	Unit
Electro-optic bandwidth	$S_{21}$	RF electrodes, from 2 GHz	10	12	-	GHz
Ripple $S_{21}$	$\Delta S_{21}$	RF electrodes, $f < 10$ GHz	-	0.5	1	dB
Electrical return loss	$S_{11}$	RF electrodes, $f < 10$ GHz	-	-12	-10	dB
$V_{\pi}$ RF @50 kHz	$V_{\pi RF_{50\text{ kHz}}}$	RF electrodes	-	5.5	6	V
$V_{\pi}$ RF @10 GHz	$V_{\pi RF_{10\text{ GHz}}}$	RF electrodes	-	6.5	7	V
$V_p$ DC electrodes	$V_{\pi DC}$	DC electrodes	-	6.5	7	V
2 <sup>nd</sup> harmonic suppression ratio	$H_1 - H_2$	Measured @5 GHz	-	70	-	dB
Input 3 <sup>rd</sup> order intercept	IIP3	Measured @5 GHz	28	30	-	dBm
RF input impedance	$Z_{in-RF}$	-	-	50	-	$\Omega$
DC input impedance	$Z_{in-DC}$	-	-	1	-	M $\Omega$

50  $\Omega$  RF input

#### Optical Characteristics

Parameter	Symbol	Condition	Min	Typ	Max	Unit
Crystal	-	-	Lithium Niobate X-Cut Y-Prop			
Operating wavelength	$\lambda$	-	1530	1550	1625	nm
Insertion loss	IL	Without connectors	-	3.5	-	dB
Insertion loss (with low IL option)	LIL	Without connectors	-	2.7	3	dB
DC extinction ratio	ER	Measured with narrow source linewidth $< 200$ MHz	20	22	-	dB
Optical return loss	ORL	-	-40	-45	-	dB
Chirp	$\alpha$	-	-0.1	0	0.1	-

All specifications given at 25°C, 1550 nm, unless differently specified

#### Absolute Maximum Ratings

Stresses in excess of the absolute maximum ratings can cause permanent damage to the device. These are absolute stress ratings only. Functional operation of the device is not implied at these or any other conditions in excess of those given in the operational sections of the data sheet. Exposure to absolute maximum ratings for extended periods can adversely affect device reliability.

Parameter	Symbol	Min	Max	Unit
RF input power	$EP_{in}$	-	28	dBm
Bias voltage	$V_{bias}$	-20	+20	V
Optical input power	$OP_{in}$	-	20	dBm
Operating temperature	OT	0	+70	°C
Storage temperature	ST	-40	+85	°C

## MXAN-LN-20

### 20 GHz Analog Intensity Modulator

#### Electrical Characteristics

Parameter	Symbol	Condition	Min	Typ	Max	Unit
Electro-optic bandwidth	$S_{21}$	RF electrodes, from 2 GHz	20	25	-	GHz
Ripple $S_{21}$	$\Delta S_{21}$	RF electrodes, $f < 20$ GHz	-	0.5	1	dB
Electrical return loss	$S_{11}$	RF electrodes, $f < 20$ GHz	-	-12	-10	dB
$V\pi$ RF @50 kHz	$V\pi RF_{50\text{ kHz}}$	RF electrodes	-	5	5.5	V
$V\pi$ RF @20 GHz	$V\pi RF_{20\text{ GHz}}$	RF electrodes	-	7	8	V
$V\pi$ DC electrodes	$V\pi DC$	DC electrodes	-	6.5	7	V
2 <sup>nd</sup> harmonic suppression ratio	$H_1 - H_2$	Measured @5 GHz, $RF_{IN} = 0$ dBm	-	60	-	dB
Input 3 <sup>rd</sup> order intercept	IIP3	Measured @5 GHz	28	30	-	dBm
RF input impedance	$Z_{in-RF}$	-	-	50	-	$\Omega$
DC input impedance	$Z_{in-DC}$	-	-	1	-	M $\Omega$

50  $\Omega$  RF input

#### Optical Characteristics

Parameter	Symbol	Condition	Min	Typ	Max	Unit
Crystal	-	-	Lithium Niobate X-Cut Y-Prop			
Operating wavelength	$\lambda$	-	1530	1550	1625	nm
Insertion loss	IL	Without connectors	-	3.5	4.5	dB
DC extinction ratio	ER	Measured with narrow source linewidth $< 200$ MHz	20	25	-	dB
Optical return loss	ORL	-	-40	-45	-	dB
Chirp	$\alpha$	-	-0.1	0	0.1	-

All specifications given at 25°C, 1550 nm, unless differently specified

#### Absolute Maximum Ratings

Stresses in excess of the absolute maximum ratings can cause permanent damage to the device. These are absolute stress ratings only. Functional operation of the device is not implied at these or any other conditions in excess of those given in the operational sections of the data sheet. Exposure to absolute maximum ratings for extended periods can adversely affect device reliability.

Parameter	Symbol	Min	Max	Unit
RF input power	$EP_{in}$	-	28	dBm
Bias voltage	$V_{bias}$	-20	+20	V
Optical input power	$OP_{in}$	-	20	dBm
Operating temperature	OT	0	+70	°C
Storage temperature	ST	-40	+85	°C

## MXAN-LN-40

### 40 GHz Analog Intensity Modulator

#### Electrical Characteristics

Parameter	Symbol	Condition	Min	Typ	Max	Unit
Electro-optic bandwidth	$S_{21}$	RF electrodes, from 2 GHz	28	30	-	GHz
Ripple $S_{21}$	$\Delta S_{21}$	RF electrodes, $f < 30$ GHz	-	0.5	1	dB
Electrical return loss	$S_{11}$	RF electrodes, $f < 30$ GHz	-	-12	-10	dB
$V_{\pi}$ RF @50 kHz	$V_{\pi RF_{50\text{ kHz}}}$	RF electrodes	-	5	6	V
$V_{\pi}$ RF @20 GHz	$V_{\pi RF_{20\text{ GHz}}}$	RF electrodes	-	7	8	V
$V_{\pi}$ DC electrodes	$V_{\pi DC}$	DC electrodes	-	6.5	7	V
2 <sup>nd</sup> harmonic suppression ratio	$H_1 - H_2$	Measured @5 GHz, $RF_{IN} = 0$ dBm	-	60	-	dB
Input 3 <sup>rd</sup> order intercept	IIP3	Measured @5 GHz	28	30	-	dBm
RF input impedance	$Z_{in-RF}$	-	-	50	-	$\Omega$
DC input impedance	$Z_{in-DC}$	-	-	1	-	M $\Omega$

50  $\Omega$  RF input

#### Optical Characteristics

Parameter	Symbol	Condition	Min	Typ	Max	Unit
Crystal	-	-	Lithium Niobate X-Cut Y-Prop			
Operating wavelength	$\lambda$	-	1530	1550	1625	nm
Insertion loss	IL	Without connectors	-	3.5	4.5	dB
DC extinction ratio	ER	Measured with narrow source linewidth $< 200$ MHz	20	25	-	dB
Optical return loss	ORL	-	-40	-45	-	dB
Chirp	$\alpha$	-	-0.1	0	0.1	-

All specifications given at 25°C, 1550 nm, unless differently specified

#### Absolute Maximum Ratings

Stresses in excess of the absolute maximum ratings can cause permanent damage to the device. These are absolute stress ratings only. Functional operation of the device is not implied at these or any other conditions in excess of those given in the operational sections of the data sheet. Exposure to absolute maximum ratings for extended periods can adversely affect device reliability.

Parameter	Symbol	Min	Max	Unit
RF input power	$EP_{in}$	-	28	dBm
Bias voltage	$V_{bias}$	-20	+20	V
Optical input power	$OP_{in}$	-	20	dBm
Operating temperature	OT	0	+70	°C
Storage temperature	ST	-40	+85	°C

MXAN-LN-10 Typical  $S_{21}$  Curve

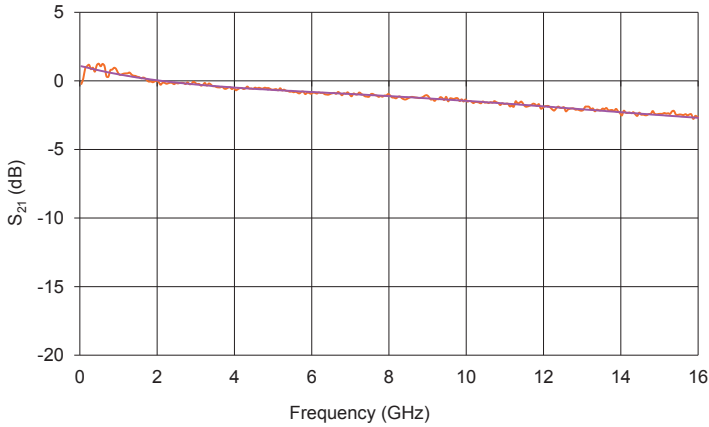

MXAN-LN-10 Typical  $S_{11}$  Curve

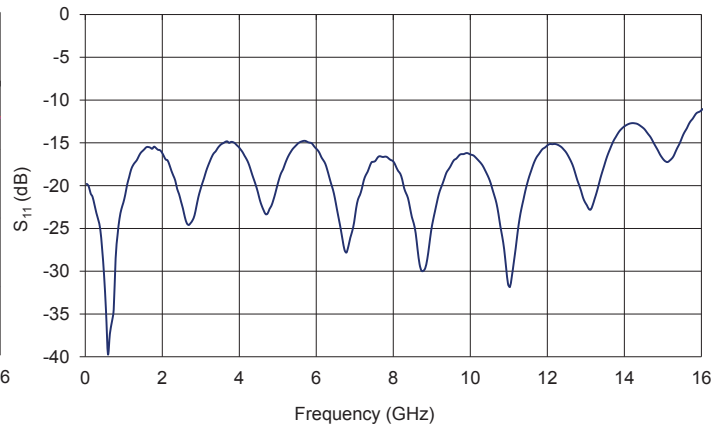

MXAN-LN-20 Typical  $S_{21}$  Curve

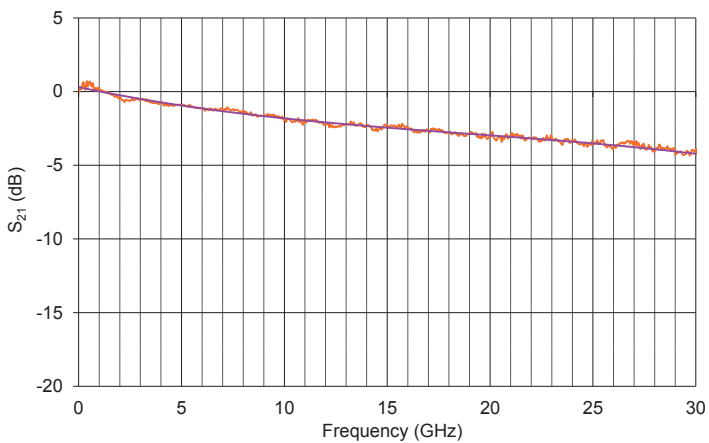

MXAN-LN-20 Typical  $S_{11}$  Curve

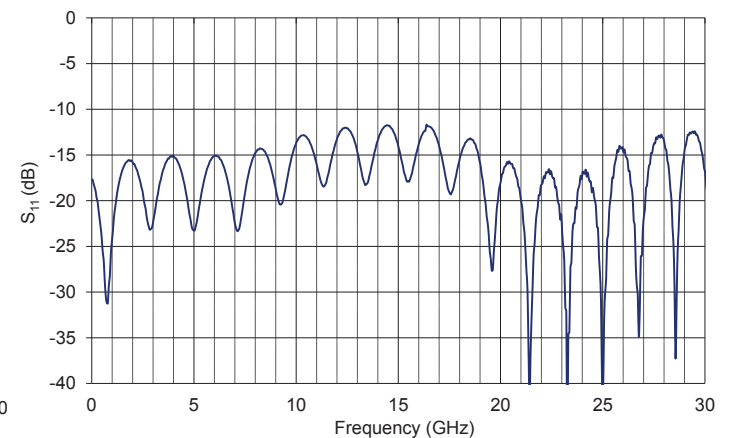

MXAN-LN-40 Typical  $S_{21}$  Curve

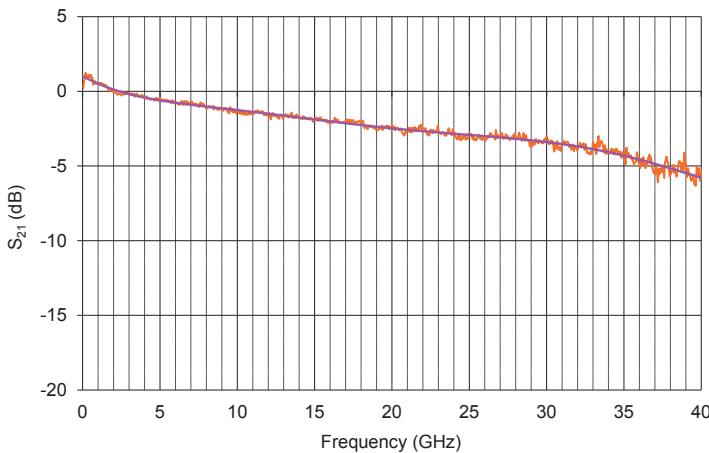

MXAN-LN-40 Typical  $S_{11}$  Curve

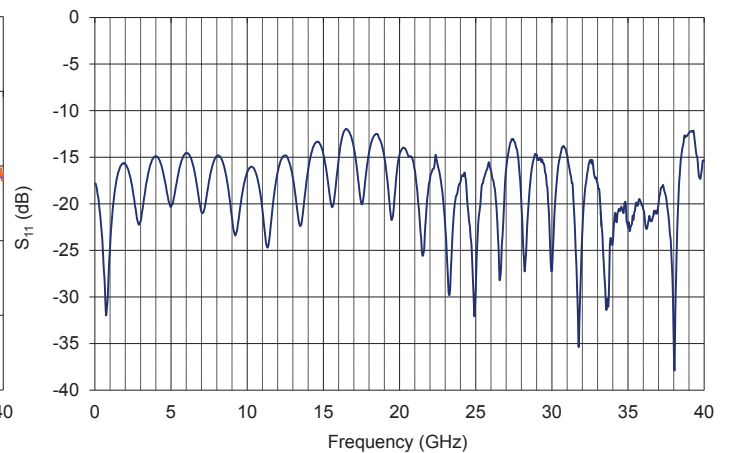

**Mechanical Diagram and Pinout**

All measurements in mm

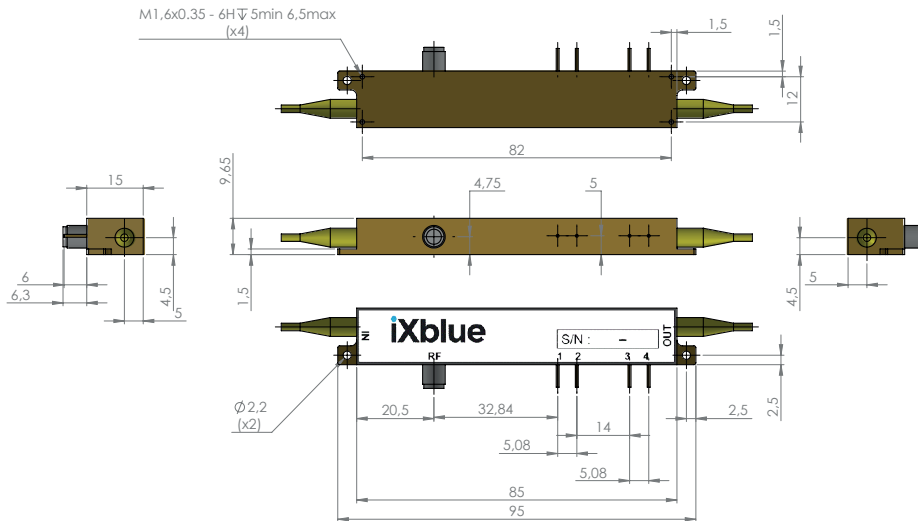

Port	Function	Note
IN	Optical input port	Polarization maintaining fiber, Corning PM 15-U25D, Length 1.5 meter. Buffer diameter 900 mm
OUT	Optical output port	Polarization maintaining fiber, Corning PM 15-U25D, Length 1.5 meter. Buffer diameter 900 mm
RF	RF input port	MX-LN-10: Wiltron female K (SMA compatible) MX-LN-20: Wiltron female K or V (optional) MX-LN-40: Wiltron female V
1	Ground	Pin feed through diameter 1.0 mm
2	DC	Pin feed through diameter 1.0 mm
3,4	Photodiode cathode, anode	Pin feed through diameter 1.0 mm

**Ordering information**

**MXAN-LN-BW-XX-Y-Z-AB-CD**

BW = Bandwidth : 10 10 GHz 20 20 GHz 40 40 GHz  
 XX = Internal photodiode : 00 Not integrated PD PD Integrated  
 Y = Input fiber : P Polarization maintaining S Standard single mode  
 Z = Output fiber : P Polarization maintaining S Standard single mode  
 AB = Input connector : 00 bare fiber FA FC/APC FC FC/SPC  
 CD = Output connector : 00 bare fiber FA FC/APC FC FC/SPC  
 Note : optical connectors are Seikoh-Giken with narrow key or equivalent

**About us**

ixBlue Photonics includes ixBlue ixFiber brand that produces specialty optical fibers and Bragg gratings based fiber optics components and ixBlue Photline brand that provides optical modulation solutions based on the company lithium niobate (LiNbO<sub>3</sub>) modulators and RF electronic modules.

ixBlue Photonics serves a wide range of industries: sensing and instruments, defense, telecommunications, space and fiber lasers as well as research laboratories all over the world.

3, rue Sophie Germain  
 25 000 Besançon - FRANCE  
 Tel. : +33 (0) 381 853 180 - Fax : + 33 (0) 381 811 557

ixblue reserves the right to change, at any time and without notice, the specifications, design, function or form of its products described herein. All statements, specification, technical information related to the products herein are given in good faith and based upon information believed to be reliable and accurate at the moment of printing. However the accuracy and completeness thereof is not guaranteed. No liability is assumed for any inaccuracies and as a result of use of the products. The user must validate all parameters for each application before use and he assumes all risks in connection with the use of the products